

H711 - Cart Mount for Logitech Rally Bar

Mount Rally Bar and Rally Bar Mini to
Heckler AV Cart Device Panel
or Device Panel XL

Designed & made in Arizona
Patented

In the box

- A** 1 x Cart Mount for Logitech Rally Bar
- B** 2 x Bracket-mounting thumb screws
- C** 2 x Bracket-mounting thumb nuts

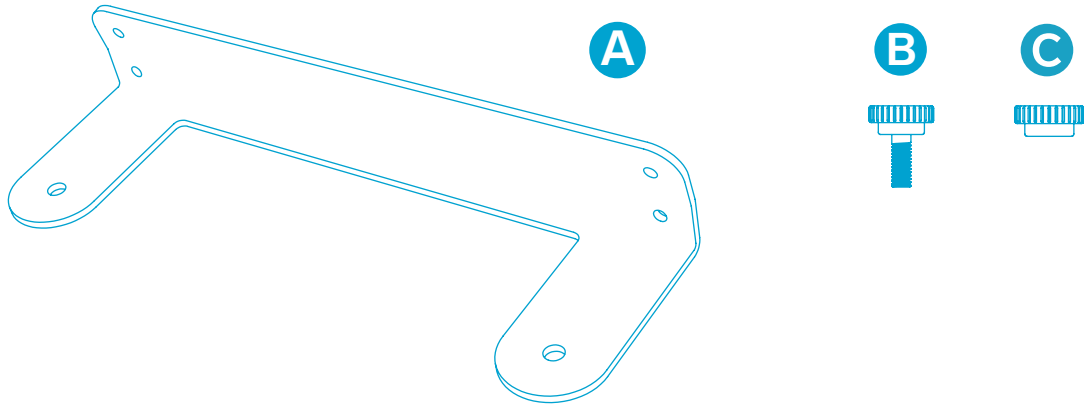

Part needed

A H702 Device Panel for Heckler AV Cart

OR

B H708 Device Panel XL for Heckler AV Cart

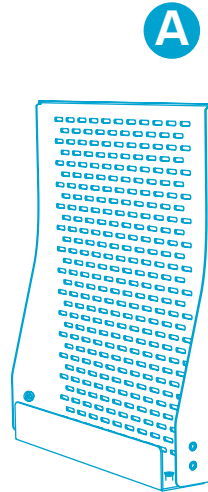

OR

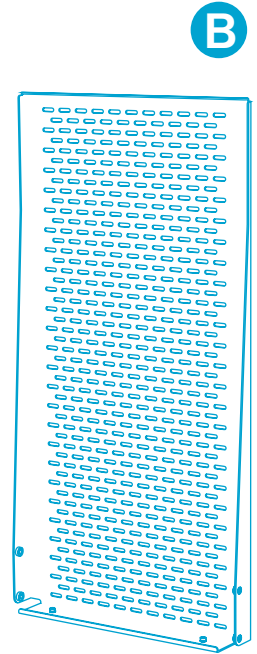

STEP 1

Determine Rally Bar/Rally Bar Mini position.

If mounting above the display,
go to Page 4.

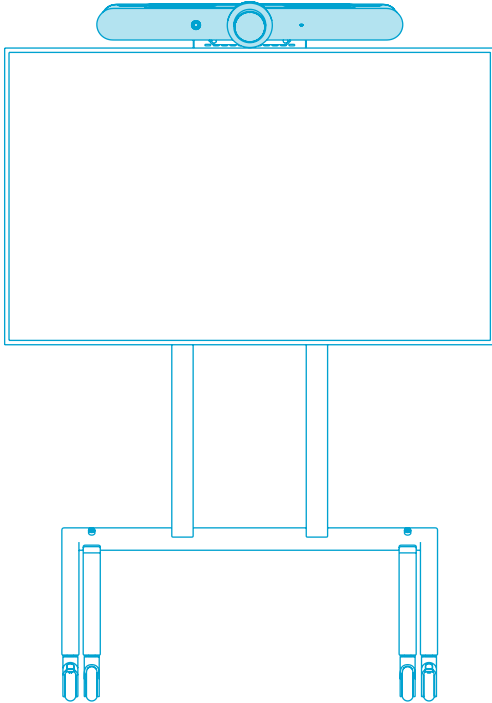

If mounting below the display,
go to Page 9.

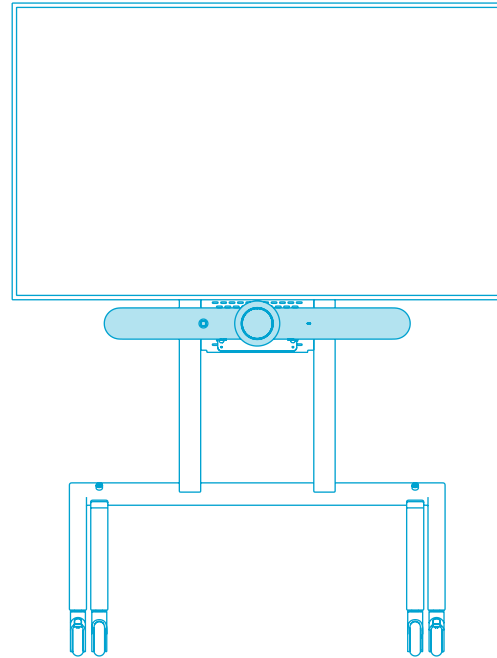

Mount Rally Bar/Rally Bar Mini above display.

STEP 2

Select your preferred mounting angle and install
Cart Mount Bracket to the Device Panel or Device Panel XL.

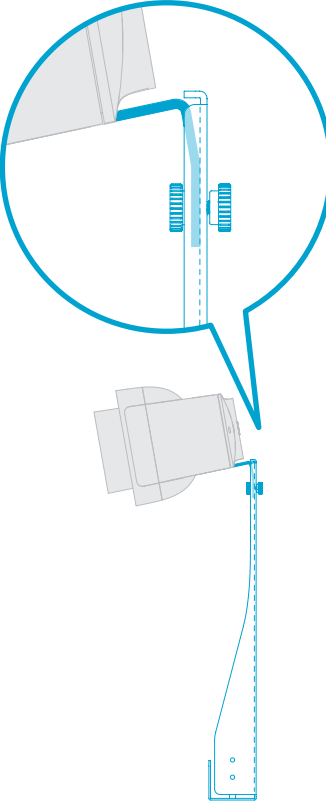
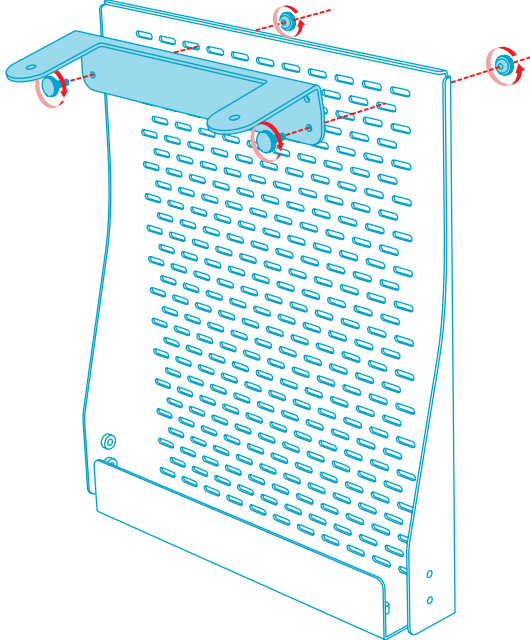
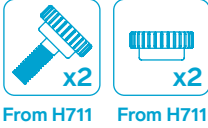

OR

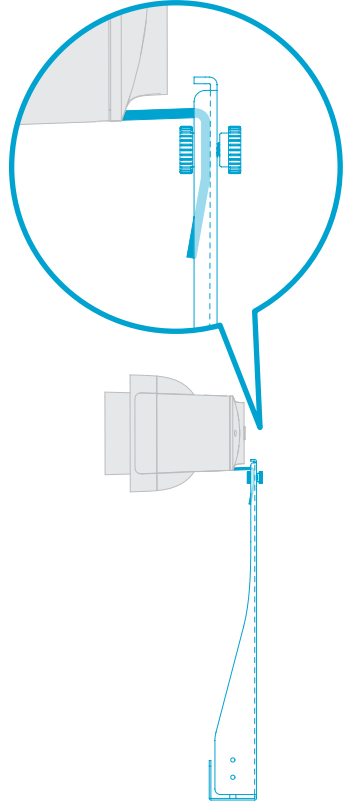

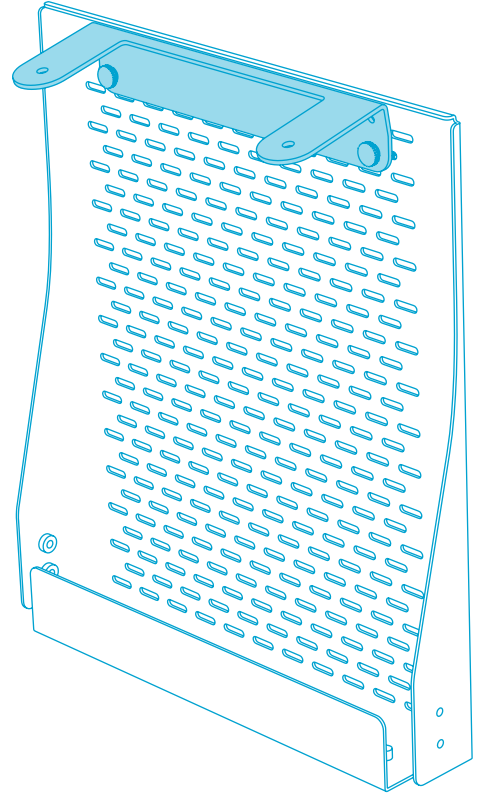
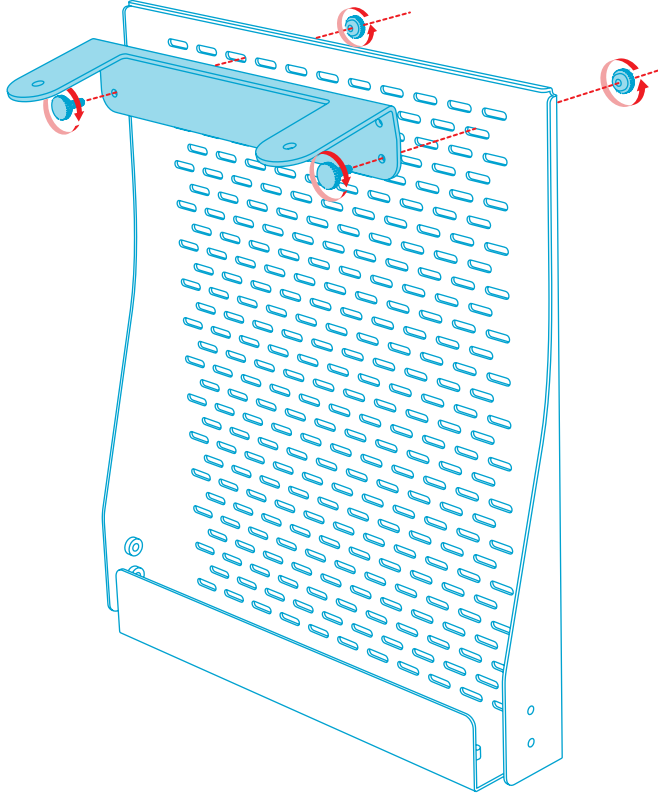

STEP 3

Pre-configure power adapter and wiring to Device Panel or Device Panel XL with included Velcro straps.



From H702
/H708

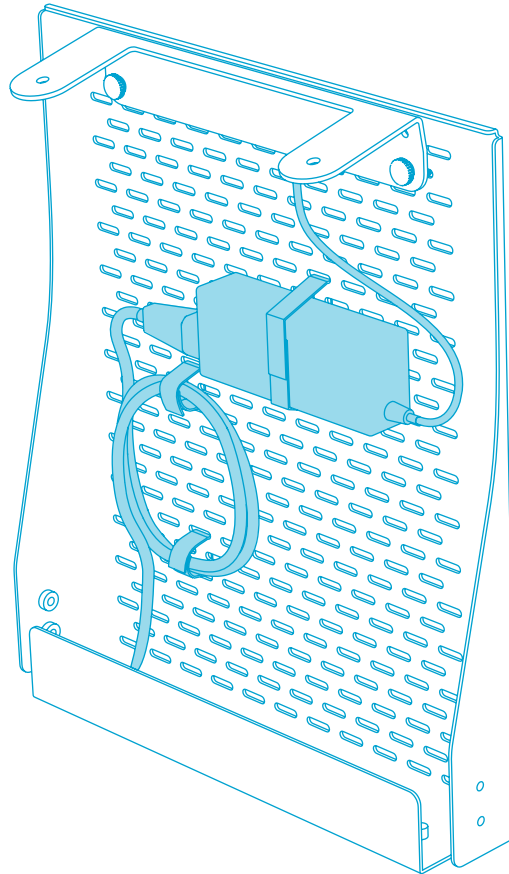

STEP 4

Install Device Panel or Device Panel XL to Display Rails.



From H702 /H708 From H702 /H708 From H702 /H708

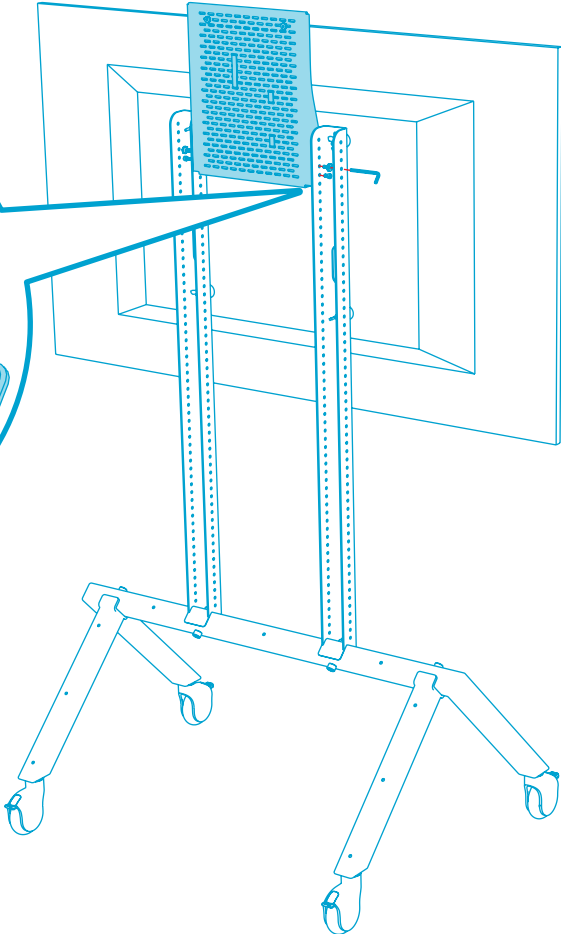
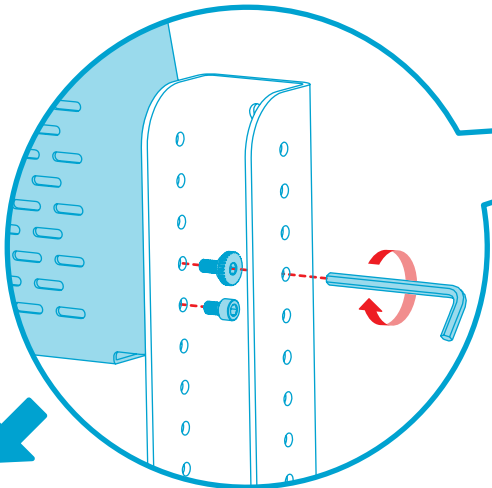
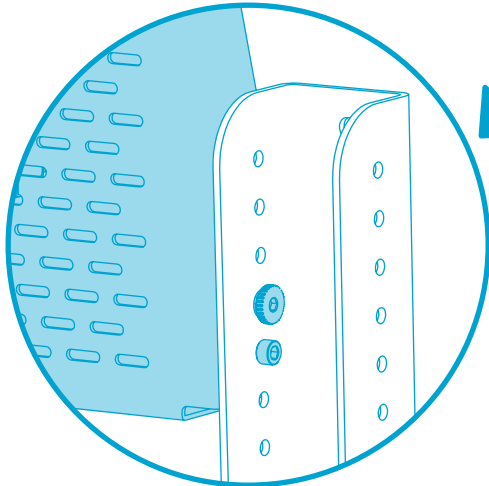

STEP 5

Fasten Rally Bar to Cart Mount.

Use the thumbscrews supplied with your Rally Bar tabletop stand.

Do not overtighten the thumbscrews.

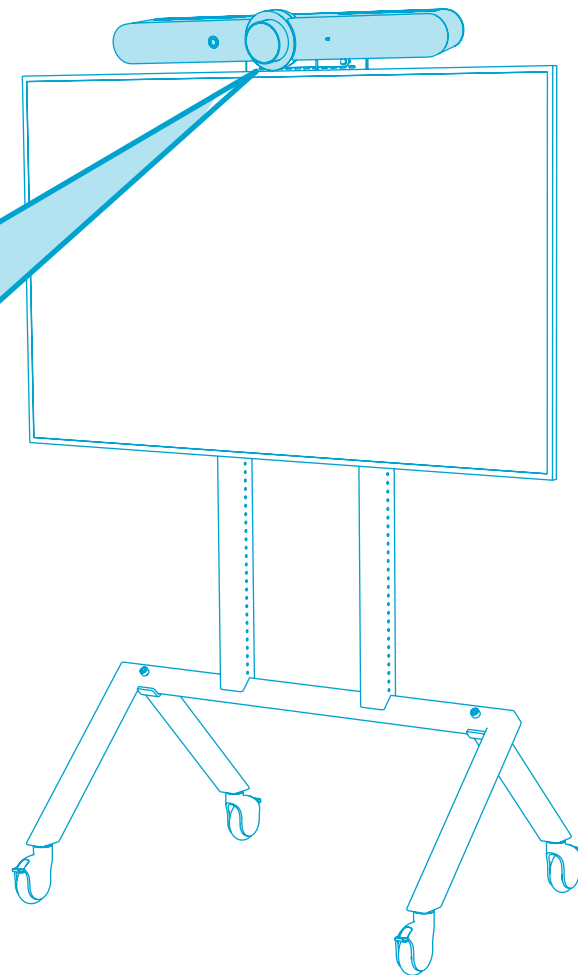
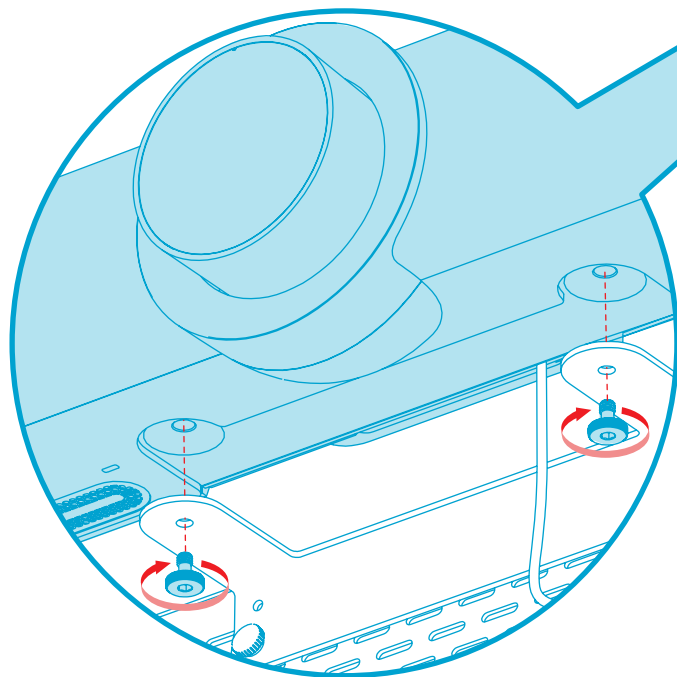

Mount Rally Bar/Rally Bar Mini below display.

STEP 2

Install Cart Mount Bracket to the Device Panel or Device Panel XL.

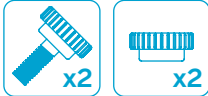

From H711 From H711

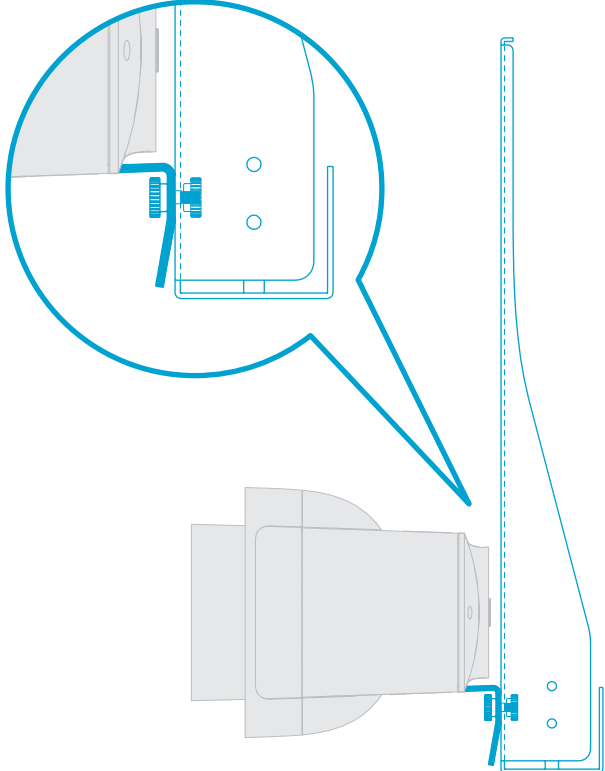
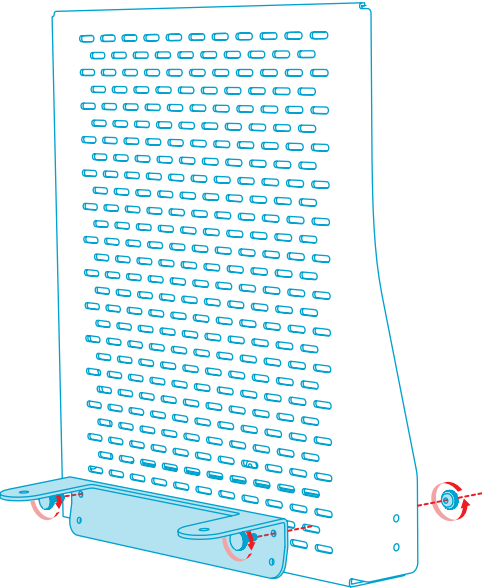

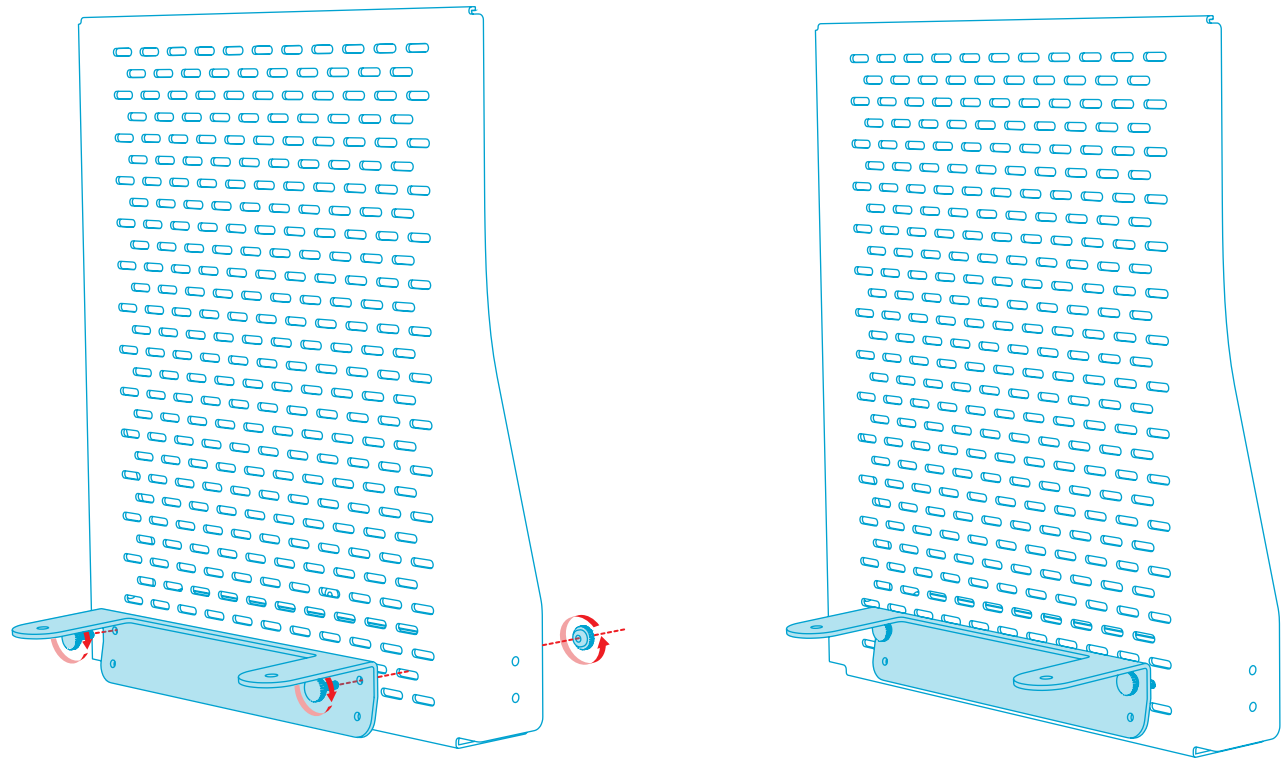

STEP 3

Pre-configure power adapter and wiring to Device Panel or Device Panel XL with included Velcro straps.



From H702
/H708

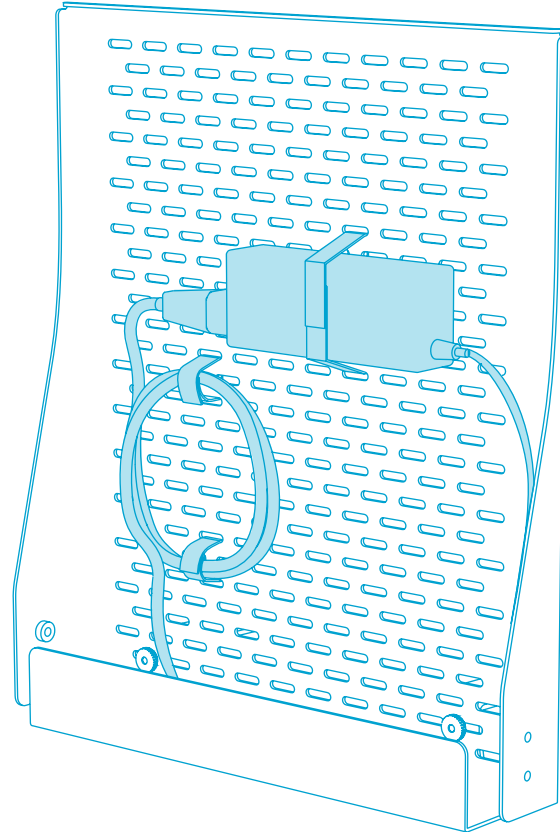

STEP 4

Install Device Panel or Device Panel XL to Display Rails.



From H702 From H702 From H702
/H708 /H708 /H708

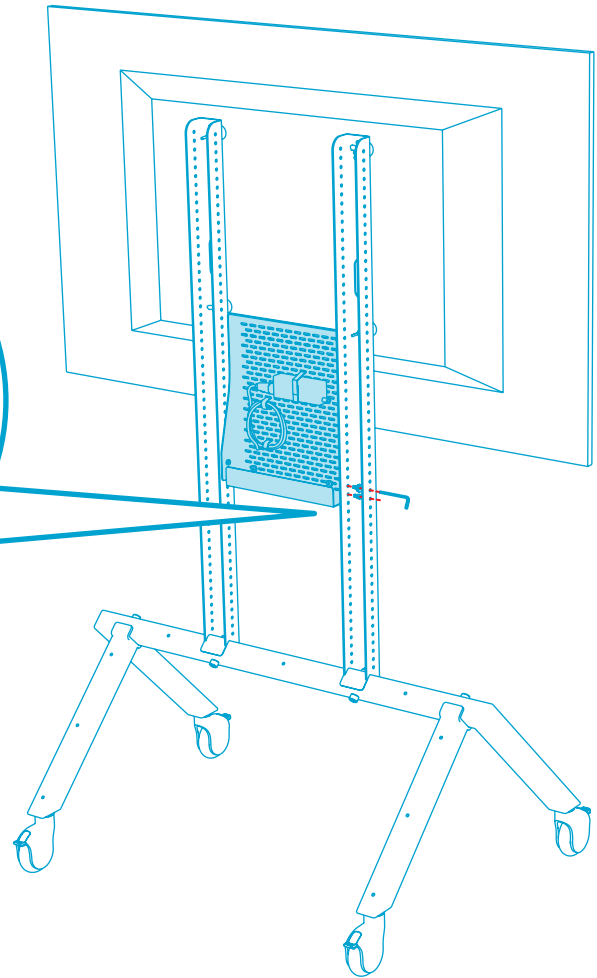
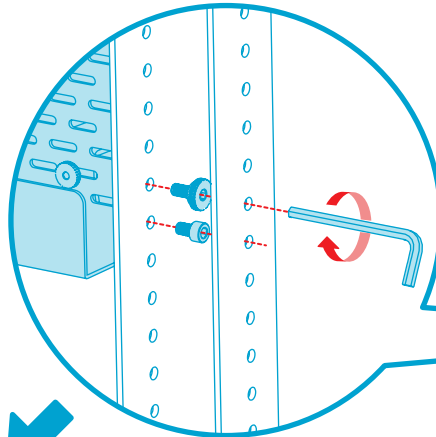
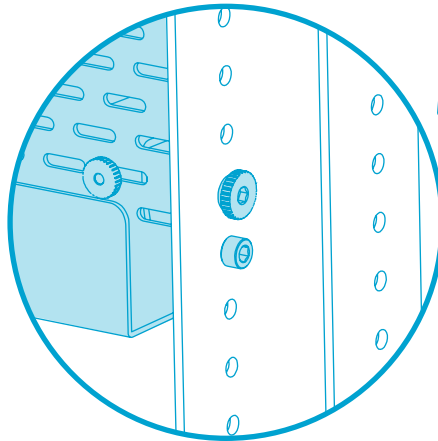

STEP 5

Fasten Rally Bar to Cart Mount.

Use the thumbscrews supplied with your Rally Bar tabletop stand.

Do not overtighten the thumbscrews.

